

OPERATING & MAINTENANCE MANUAL



COMPACT CWS SCAFFOLD HOISTS CWS80 / CWS160 / CWS230 / CWS300 110V or 240V x 1ph

Part Nos: CWS80: 9085 (110V), 9087 (240V) / CWS160: 9088 (110V), 9089 (240V)
CWS230: 9846 (110V), 9091 (240V) / CWS300: 9092 (240V only)

CONFORMING TO
BS EN14492 Cranes – Power Driven Winches and Hoists – Part 2: Power Driven Hoists

CONTENTS

INTRODUCTION	3
STANDARDS & BHW GROUP LTD	3
HOIST INFORMATION	
HOIST SPECIFICATIONS	4
HOIST DIMENSIONS	5
HOIST LABELS	5
HOIST FEATURES	6-7
OPERATIONAL SAFETY	
ENVIRONMENTAL CONSIDERATIONS	8
THE HOIST OPERATOR	8
WORKING ON SITE	8
OPERATION	
PRE OPERATION CHECKS	9
INITIAL LUBRICATION	9
CONNECTION TO ELECTRICAL SUPPLY	9
COMMISSIONING THE HOIST	9
NOTES ON DUTY CYCLES	10
ELECTRICAL CIRCUITS	10
WIRE ROPES & HOOKS	
ISO 4309:2004/2010 DIRECTIVE	11
CARE OF THE WIRE ROPE	11
REPLACING THE WIRE ROPE	11
MAINTENANCE	
TAKING CARE OF THE HOIST	12
ROUTINE MAINTENANCE	12
TROUBLE SHOOTING	13
WINCH PARTS	
PARTS DIAGRAM CWS 80	14
PARTS DIAGRAM CWS 160 / 230 / 300	15
PARTS LISTS CWS 80 / 160	16
PARTS LIST CWS 230 / 300	17
WARRANTY	18

INTRODUCTION

PLEASE READ THIS MANUAL CAREFULLY BEFORE INSTALLATION OR OPERATION OF THE HOIST

Those responsible for the installation and the operation of this hoist must read and understand this manual. The first section deals with the installation requirements and the second section is for the user and provides information to ensure safe use of the hoist.

These hoists are of the highest quality and have been designed to give a robust and efficient service for many years if care and attention are given at all times to correct installation, operation and maintenance.

PLEASE KEEP THIS MANUAL WITH THE HOIST.

NOTE: Hire companies should make the hirer fully aware of the safety issues and correct operation of this hoist as detailed in this manual and ensure that the proposed operator is suitably trained.

STANDARDS & BHW GROUP LTD

The British Standard: BS EN14492-2 for power driven hoists provides the means for conformity to essential Health and Safety requirements of the EN Machinery Directive and the essential Health & Safety at Work Act 1974.

Selecting the correct hoist for the application is very important not only from the health and safety aspect, but also to maximise product life and ensure the best value for money.

BHW Group Ltd products are fully compliant and carry a UKCA and CE mark. A Declaration of Conformity is also supplied with each product. BHW Group Ltd aim to ensure the correct machine is supplied to suit the application and we welcome the opportunity of discussing the proposed application and offer advice. It will help us considerably if information regarding the maximum and average loads to be lifted or pulled - and approximate frequency of use can be provided.



PRE OPERATION CHECK

- Check for any transit damage.
- Check that all fixings and joints are tight and secure.
- Check the capacity of the hoist versus intended loads and ensure it is adequate for the task.
- Check that all external wiring is in good order.
- Check the wire rope to ensure that there is no damage – (see notes on Wire Ropes & Hooks, page 11).
- Check that the suspension point is fully capable of taking the proposed load bearing of operation.
- Check that the hooks (top and bottom) are in good order, the top hook is fully secured on the suspension point and that potential travel on the load hook is unimpeded.

SETTING UP HOIST PRIOR TO USE.

1. Check that all components of the hoist are sound and in good working order.
2. Install and check the hoist in accordance with instructions, ensuring that the hoist is suited to the task.
3. The hoist is supplied with the wire rope already fitted to the drum. Thread the wire rope through the overwind limiter frame. Remove the cotter pin and pin from the load hook. Pass the 'EYE' of the rope through the top plate and secure in place with the pin. Insert cotter pin and splay ends. Check that all fittings are secure. (See section on Features – page 7 or Wire Ropes & Hooks on page 11).
4. Hooks must have a safety latch and a minimum rated capacity of 1.0 tonne.
Use only high tensile grade 80 or 100 to comply with BS EN14492-2 standards.
(Hooks supplied as standard from BHW Group Ltd are rated and stamped for lifting and have a safety factor of 4:1. Hook capacity for these machines are selected to ensure they are large enough to take webbing straps).
5. Fully test and check all wanderlead operations including Emergency Stop.
6. Ensure that hoist has suitable circuit breaker or fuse as part of the power supply and suitable earthing.
7. When installing on site, test the hoist, check the integrity of the selected mounting and ensure that fixings are capable of supporting the intended loads.
8. Check that the wire rope is evenly wound on to the drum and generally fit for use, replace if damaged or worn (See section on wire ropes).
9. You are also advised that adherence to the directive ISO4309:2004/2010 regarding care, installation and disposal of wire ropes also applies to this range of hoists. (See section on Wire Ropes & Hooks, page 11).

HOIST INFORMATION

HOIST SPECIFICATIONS

Models	Compact CWS Scaffold Hoists 80kg / 160kg / 230kg / 300kg 110V or 240V x 1ph (300kg = 240V x 1ph only) BS EN 14492-2 Compliant
Typical Uses	Vertical hoisting and lowering of loads.
Construction	Steel gears running in oil, in alloy housing
Motor	110V or 240V x 1ph AC (300kg = 240V) Rated IP44 (see ratings below).

SPECIFICATIONS		CWS80		CWS160		CWS230		CWS300
Voltage options		110V	240V	110V	240V	110V	240V	240V only
Lifting:	Capacity	80kg		160kg		230kg		300kg
	Height	23m		30m		24m		24m
Weight:	Hoist only	9kg		14kg		15kg		17kg
	Total kit	18kg		25kg		26kg		28kg
Line speed:	1st layer	18m/min		15m/min		9m/min		9m/min
	Last layer	30m/min		25m/min		14m/min		13m/min
Duty cycle:		All Scaffold Hoists have a duty cycle of 25%, with a maximum of 60 starts per hour						
Wire rope:	Diameter Ø	4mm		5mm		5mm		5mm
	Length	24m		31m		25m		25m
	Rope construction	7 x 18 wire core, spin resistant, galvanised for longer rope life. Factor of safety = 5:1 (for lifting)						
Motor type:		All Scaffold Hoists have a brush type induction motor						
Motor outputs:	Kilowatts	0.8kW		1.2kW		1.2kW		1.5kW
	Amperes	8A	4A	12A	6A	12A	6A	7.5A
Braking:		Motor: Electronic via resistor Gears: Mechanical ratchet brake						
Drum:	Length	46mm		110mm		110mm		110mm
	Diameter Ø	70mm		94mm		94mm		94mm
	Flange Diameter Ø	158mm		155mm		155mm		155mm
Rope Ø to mean drum Ø ratio:		18:1		20:1				

* Mean drum diameter = the drum diameter plus the diameter of the wire rope.

Wanderlead	Tough, 3 button hand held control with 10m lead. IP65 (see below). Includes Emergency Stop. Other lead lengths are available on request.
Hooks (as supplied with CWS hoists)	1 tonne rated with safety latch and top plate. High tensile grade 80 or 100 in compliance with BS EN14492-2 standards.
IP (Ingress Protection) Ratings	Motor = IP44 - Protection from entry by solid objects with a diameter or thickness greater than 1mm. Protection against water splashed from any direction – limited ingress permitted. Wanderlead Control = IP65 – Totally protected against dust. Protection against strong jets of water – limited ingress permitted.
Machine Insulation Class	F - Maximum operation temperature of 155° C (311° F). Allowable temperature rise at full load 1.0 service factor motor = 105° and at full load 1.15 service factor motor = 115°.
Lubrication & Recommended Oils	Gear Box: EP80/140 or equivalent
Noise Level	80db
Ambient Temp. Operating Range	-10°C to 40°C (humidity must be below 90%)

HOIST INFORMATION

CWS HOIST DIMENSIONS

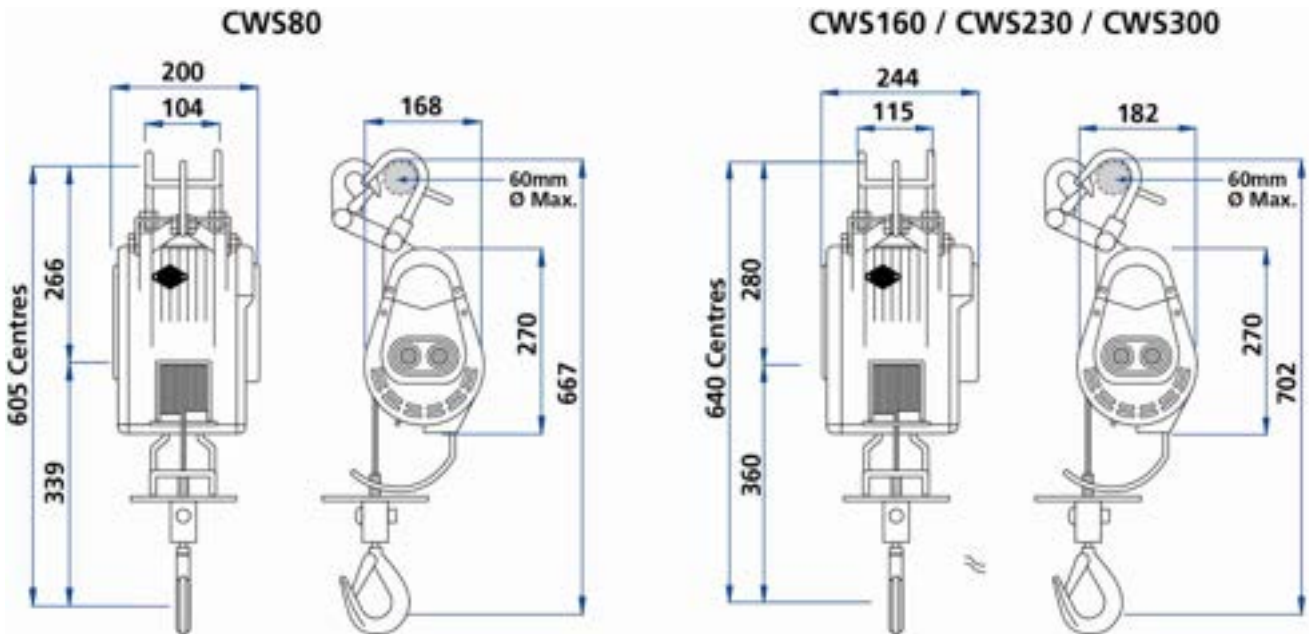

CWS HOIST LABELS

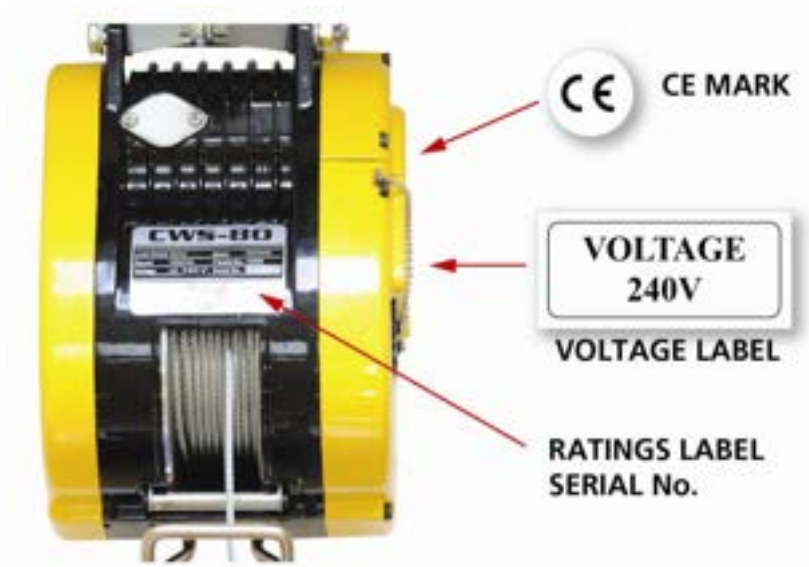

CWS HOISTS - FEATURES

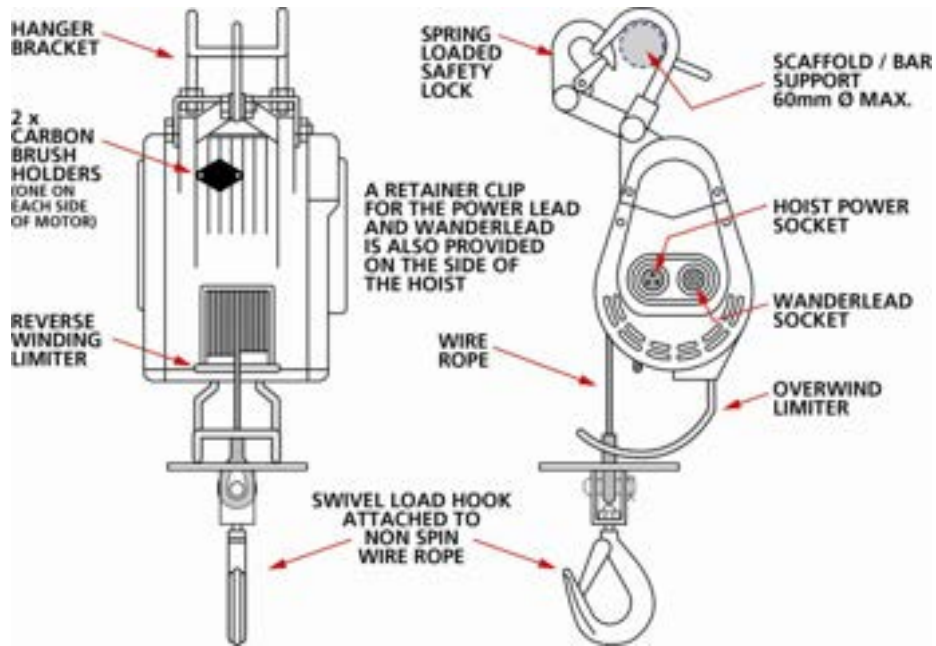

HANGER BRACKET & SAFETY LOCK

It is generally envisaged that a secure, load tested scaffold or bar will be the main support for the hoist. The suspension point should be of a correct size (60mm Ø maximum) to admit the top hanger of the hoist and allow it to rest properly on the scaffold bar with the safety catch locked. If the suspension bar is open ended, suitable measures should be taken to 'close' it (i.e. a scaffold bracket) to ensure that the hoist will not fall off.

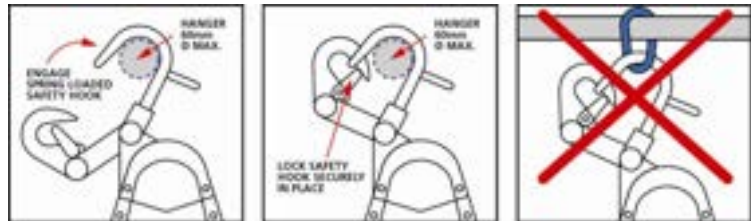

Do not suspend the top hanger on additional ropes or stops as this will destabilise or weaken the mounting and may also cause the hoist to spin when in operation.

The support bar and its supporting structure must be capable of carrying 125% of the hoist's rated capacity (Safe working load) and approved for safe operation.

An optional suspension jib arm capable of turning through 180° with an integral lock to secure the hoist, is available from BHW Group Ltd, call sales on +44 (0)1482 223 663 and quote part no. 2199. Please note: This jib arm is load tested to 230kg maximum.

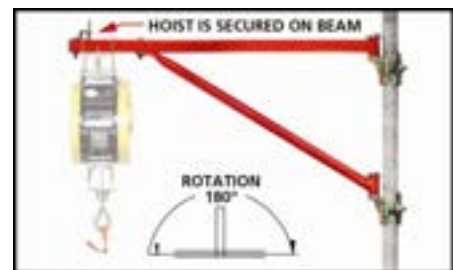

CARBON BRUSH HOLDERS

There are two apertures for the motor carbon brushes located on either side of the motor housing.

Access to either of the carbon brushes is made by unscrewing each cover plate and then unscrewing the black plastic grub screw inside. As the brushes are on springs, they will pop out easily from the housing for inspection or replacement. Brushes should be replaced if worn to less than 7.5mm, or are damaged in any way. When replacing the brushes, please ensure that the red rubber 'O' ring is still in place around the aperture, as this seals each cover.

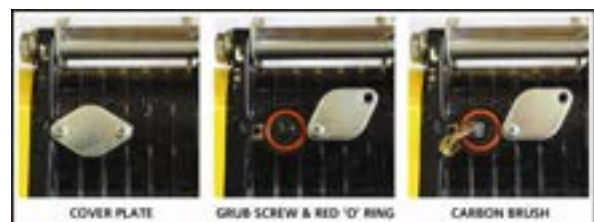

Brushes should be replaced in pairs, not singly. They are available from BHW Group Ltd, part no. 2303.

BRUSHES ARE NOT COVERED UNDER WARRANTY.

CWS HOISTS - FEATURES (continued)

REVERSE WINDING LIMITER

This is to prevent over winding and causing the wire rope to be rewound on to the drum in reverse. When the wire rope is fully paid out, the rope will shift from position 'A' to position 'B' as shown in the diagram opposite. When the rope touches the reverse limiter bar, lowering will automatically stop. Should this happen, use the 'UP' button on the wanderlead to return the wire rope to position 'A'. A prevention of this is to keep at least 5 wraps or more of wire rope on the drum at all times.

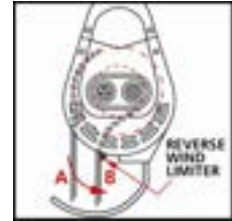

SWIVEL LOAD HOOK & SPIN RESISTANT WIRE ROPE

The appropriate wire rope and load hook are both supplied with new CWS hoists, with the wire rope already installed. Ropes and hooks for CWS hoists are specifically calibrated for the safe working load of each model. The wire rope is passed through the top plate of the hook and secured with the pin and cotter pin provided.

Hooks are swivel type, with a safety catch and a customised top plate designed to operate the overwind limiter. **DO NOT fit a load hook without an integral top plate as this will render the overwind limiter ineffective.**

Ropes should be spin resistant, galvanised 7 x 18 wire core.

Replacement ropes and hooks should be of the same relevant calibration and are available from BHW Group Ltd sales. Please refer to the section on Parts (pages 14-17).

WIRE ROPES ARE NOT COVERED UNDER WARRANTY.

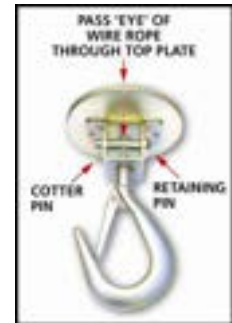

OVERWIND LIMITER

Designed to prevent over winding into the drum when lifting. When the flat plate attached to the swivel hook hits the overwind limit lever, hoist operation will automatically stop.

The distance between the bottom of the hoist and the bottom of the overwind limiter should be: CWS80 = 80-100mm; CWS160/230/300 = 70-90mm. Hoist operation can be resumed by pressing the 'DOWN' button.

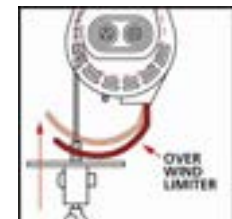

POWER AND WANDERLEAD SOCKETS

The power socket and wanderlead socket are protected with screw in dust covers which should be replaced when the ports are not in use.

HOIST POWER SOCKET

The power lead provided with the hoist has a 3 pin bayonet / screw tight plug on a 5 metre lead to a 3 pin socket for either 110V or 240V depending on the voltage model.

It is not recommended to extend the power lead to above 20 metres as there will be voltage drop which will affect performance of the hoist.

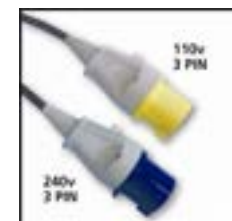

WANDERLEAD POWER CONTROL WITH EMERGENCY STOP

The wanderlead provided with the hoist uses a 7 pin bayonet / screw tight plug on a 10 metre lead to a 3 button (including Emergency Stop) control. Press the 'UP' and 'DOWN' buttons to activate the hoist, activity will stop once either of these buttons are released.

EMERGENCY STOP If the emergency stop button is used, hoist operation will immediately cease. Once the operator is sure that any potential problem with operations has been solved, the hoist can be put back into use. To do this, the emergency stop needs to be reset by a small turn clockwise to release the button. 'UP' and 'DOWN' control can then be resumed.



NOTE: Cables should be kept away from the area of operation. Both cables should be attached to the hanging clip on the side of the motor housing. It is a good idea to also attach the cables to a hook above the hoist, or place the wires over the suspension bar where possible to ensure that cables do not obstruct the operation of the hoist.

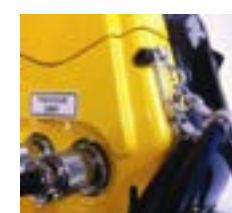

OPERATIONAL SAFETY

ENVIRONMENTAL CONSIDERATIONS

Protect the hoist from unsuitable environmental conditions. The motor is IP44 rated, the wanderlead control is IP65 rated.

Avoid temperatures under -10° C or above 40° C. Conditions with humidity above 90% may also affect hoist performance.

Avoid heavy acidic or salt environments. Protect the hoist and controls from excessive exposure to rain or snow or other moisture ingress.

As with all electrical equipment, general exposure to excessive dust pollution, gas emissions or flammable / corrosive liquids, or any potentially explosive environment should also be avoided.

THE HOIST OPERATOR

The hoist should be operated by designated and fully trained operators only. Operators should wear suitable workwear for on site operations including safety gloves, helmets, steel reinforced footwear and protective clothing.

The operator should not engage in any other activity which will divert attention from operating the hoist.

Operators are advised to check that the top hook is safely attached to the suspension point, that the safety catch on the hook is fully closed and the suspension point is fully capable of supporting lifting operations. The hoist should be further secured or bracketed to the suspension arm to prevent it coming off of the suspension point. Open ended suspension bars should have an additional bracket or suitable fixture at the end point.

The power supply lead should be firmly screwed into the socket, and the wanderlead screwed tight to its socket and both clipped to the housing before use. Both are supplied with a retaining plate attached to the cable, and the hoists are supplied with a side clip for this purpose (See previous page). Extensions attached to the 3 pin power socket should use the approved 3 pin plug (for either 240V or 110V as appropriate, and should not exceed an additional 15 metres – to avoid voltage drop.

Prior to use, the operator should check each operation mode (lift / descend / emergency stop) to ensure that all hoist activities are fully operational. Operators should also make sure that loads are safe to move and that the working area is clear of personnel and obstructions.

Operators should not attempt to use the hoist if any aspect of the lifting operation or its surrounding environment is deemed unsafe.

WORKING ON SITE



Hoists should **NEVER** be used for the transport or lifting of personnel. Loads should **NEVER** pass over the heads of personnel or in any way compromise on site safety.

Using the wanderlead, stand away from the load and use the lift or descend buttons according to need. Use suitable chains or strops to engage the load on to the lifting hook. Make sure that the load and its route is not obstructed in any way.



The wire rope must form a straight line from the load hook to the suspension point. All loads should be securely hitched, PROPERLY BALANCED and central to the lift, with the load hook safety latch closed, before any lift is made.

If the load is not balanced and centred correctly the wire rope will bunch to one side of the drum, impede operation and damage the wire rope and drum flange. An unbalanced or off centre load is also dangerous.



WATCH WHAT YOU ARE DOING. Do not get distracted from the task. Always keep an eye on the hoist and the load to ensure safe operation.

NEVER WRAP THE WIRE ROPE AROUND A LOAD TO ENGAGE THE HOOK.
NEVER STAND UNDERNEATH, OR CLOSE TO THE LOAD.
WEAR PROTECTIVE CLOTHING – ESPECIALLY GLOVES.



Make sure that the hoist is fully capable of lifting the intended load.

DO NOT attempt to lift loads that are beyond the hoist capacity (See specifications, page 4).

NEVER use the hoist beyond the rated duty cycles shown in specifications.

The efficiency and life of a CWS hoist is dependent on weights of loads and working frequency. All CWS hoists are rated at a 25% duty cycle, with a maximum of 60 starts per hour – this includes lifting and lowering. Exceeding the duty cycle or overloading the hoist will cause unnecessary stress to component parts, and shorten the life of the machine, or may cause it to fail.

OPERATIONAL SAFETY

CHECK ALL EQUIPMENT: The hoist, power lead, wanderlead, wire rope - and any chains, ropes and slings used for lifting should be continually inspected for damage or obvious wear that could make them unsafe to work with. Damaged accessory items should be replaced, not repaired (See notes on Routine Maintenance, page 12).

MAKE SURE THE HOIST IS SAFE WHEN UNATTENDED: Before leaving a hoist unattended, the operator should lower any load onto the floor or on to an appropriate support and disconnect the hoist. The unloaded hook should be raised clear of all passing personnel and traffic. The hoist should be fully switched OFF when not in use. Wanderleads, power leads, strops and slings etc., should be neatly stowed away to avoid any trip hazard.

OPERATION

HOIST - INITIAL LUBRICATION

Hoist parts should be suitably lubricated before the hoist is put into use.

External moving parts should be lubricated with a light engineering oil.

Gearbox - The hoist has been supplied from new with the gearbox pre-filled with Castrol Alpha Series SP-220. The viscosity (cSt) is 226.14/19.5 at 40°C. Gear lubrication is very important to ensure the long life of the hoist. When replacing oil, please take note of the following advice:

For ambient temperature of approx. -10° to +40°C, a gear oil of mm²/S at 40°C with mild high-pressure additives should be used.

Examples: Din 51502 Clp 220, E.G. BP Energol Gr-Xp 20, Esso Spartan Ep 220, Shell Omala Oil 220, Mobilgear 630 or Aral Degol Bg 220.

Under higher or lower than ambient temperatures, the type of oil used for the gearbox should be adapted to the specific conditions.

DO NOT USE GREASE OR OIL ON THE WIRE ROPE. USE A PROPRIETARY WIRE ROPE LUBRICANT.

CONNECTION TO THE ELECTRICAL SUPPLY – 110V or 230V / 240V?

An AC x 1ph supply is required at the appropriate voltage for the hoist. The supply voltage and frequency at which the hoist operates is marked on the motor rating plate as **either 110V or 240V x 1ph.**

IT IS IMPERATIVE TO CHECK THAT YOU ARE USING THE CORRECT VOLTAGE.

Cables supplying the hoist with power should be kept clear of the operating area and not impede the hoist. A suitable circuit breaker or fuse should be installed in the power supply to the hoist, and checked regularly.

COMMISSIONING THE HOIST

On completion of pre-operation, but before the hoist is put into regular service, the following procedures should be carried out.

- Isolate the power supply.
- Check that all mechanical and electrical joints and connections are tight and secure.
- Connect the wanderlead control to the side of the hoist, screw the threaded fitting home and attach cable to the retention clip on the side of the hoist.
- Connect the power cable to the side of the hoist and screw into place attach cable to the retention clip on the side of the hoist.
- Switch on power supply.
- Run the full extent of hoist without a load and check that the operation is smooth at all times. A slight tension on the wire rope is advised to ensure smooth running to and from the drum.
- Test both light load and full load conditions.
- Check operation of hoist emergency stop, under both light load and full load conditions.

NOTE: If the hoist is not being used on a regular basis it should be powered in and out from time to time to minimise corrosion of the internal motor components that may occur due to condensation. Energising the motor will generate heat, which will help dissipate any moisture.

OPERATION

CIRCUITRY

The basic circuit details for 110V and 240V are shown below:

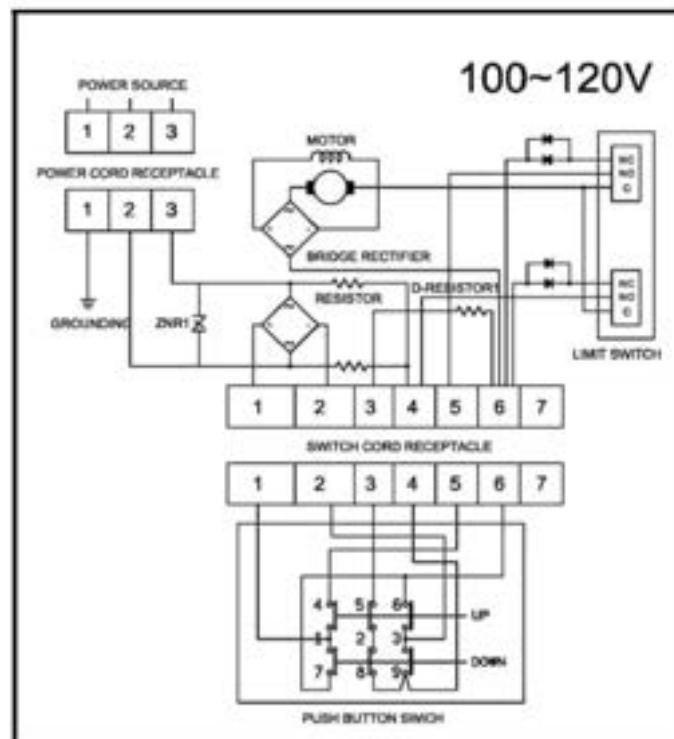
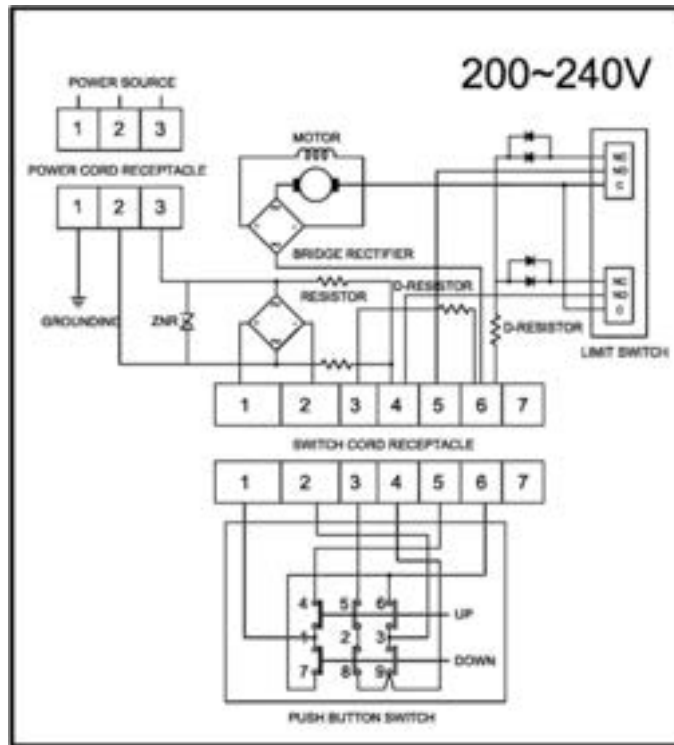

WIRE ROPE INFORMATION

NOTE: ISO 4309:2004/2010 – WIRE ROPES DIRECTIVE

ISO 4309:2004 / 2010 details guidelines for the care, installation, maintenance and examination of wire rope in service on winches, hoists and cranes, and enumerates the discard criteria to be applied to promote the safe use of the machinery.

It is important that these guidelines - for safe care, installation and ultimately disposal of wire ropes is strictly adhered to according to this directive.

For hoisting applications the minimum breaking force (MBF) of the wire rope must be 5 x the lifting capacity of the hoist. The ratio of wire rope diameter to mean drum diameter* is usually at least 15:1. This will vary according to the application, the average operating time per day and the average and maximum weights being lifted.

CARE OF THE WIRE ROPE

It is most important that the wire rope is inspected on a regular basis, for kinks, flat spots, broken strands and other damage caused by wear and tear or possible misuse.

Check both the rope and the hook and replace under any of the following circumstances:

- 10 strands of rope or more broken with a space of 25mm (See fig.1).
- Rope shows visible signs of wasting (See fig.2).
- Deformed or excessively corroded rope.
- Twisted rope.
- Bent rope.
- Broken or faulty safety catch on hook
- Damage or distortion to steel plate above hook

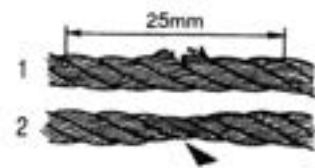

The wire rope or load hook should be replaced if damaged or worn.

After using the hoist always check to ensure that the wire rope is layered evenly on the drum. If this is not the case, power out the wire rope and rewind it to ensure even layers. This will significantly extend wire rope life. Normally the tension can be applied by hand – wear gloves.

Under no circumstances wrap the wire rope around the load being recovered and then attach the hook back on to the rope. This will result in serious rope damage or breakage. Always employ a chain or webbing strap from the hook to the load.

REPLACING THE WIRE ROPE

1. Wearing protective gloves (at all times during the replacement of the wire rope), power out the old wire rope from the hoist until fixtures are visible on the drum.
2. Using a suitable allen key, unscrew and remove the grub screw securing the rope in the drum and set aside.
3. Remove old wire rope by sliding the end sideways into grub screw hole and pulling it out. Set old rope aside for disposal.
4. Uncoil the new wire rope and lay in a line on the ground in such a way that will avoid kinking or tangles when winding on to the drum.
5. Thread the 'PLUG' end of the new wire rope between the tines of the overwind lever. Insert plug end of wire rope into drum casing and slide sideways to clear grub screw hole. Replace grub screw using allen key and tighten into place.
6. Insert the 'EYE' end of the new wire rope through aperture in the steel plate above the hook, pull through and secure rope eye to the load hook, using the pin and cotter pin previously removed (replace cotter pin if unfit for further use).
7. Applying hand tension to the wire rope, wind in the rope on to the drum using the 'UP' button. Ensure even winding throughout this operation, as uneven winding will cause bunching and may damage the rope and shorten its life.
8. Suitably pack and dispose of the old wire rope safely and responsibly.

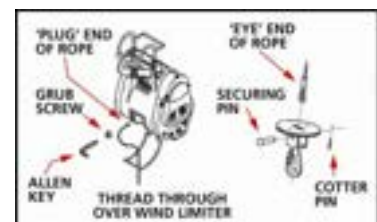

WIRE ROPES ARE NOT COVERED BY WARRANTY.

TAKING CARE OF THE HOIST – HANDY TIPS

CWS hoists are a valuable item of equipment for working on site, but care should be taken to ensure the hoist is packed away and stored in a responsible manner to minimise potential damage to external parts. It is recommended that either a suitable storage suspension point is fitted to vehicles or storage areas, or at least that the hoist is protected by a suitable storage bag, protective covering or kept in a storage box. CWS hoists should be routinely cleaned before taking off site or into storage.

ROUTINE INSPECTION & MAINTENANCE

To maintain optimum performance and condition of your CWS Hoist, it is important to carry out periodical checks.

BRAKING: Check continuously each time the hoist is used and following a full service.

There are two braking systems. One is a ratchet system, which stops the load from back driving the winch only. The second unit is a resistance coil which dissipates the excess current produced when a heavy load is lowered; this stops the motor from over speeding due to the load back driving the motor when lowering over a long distance. Therefore to test correctly, a load would have to be put onto the hoist to check that the load stops correctly over a short distance and that the load does not over run over a long distance. All this should be observed during a normal working schedule when it was last used or during a full service.

CARBON BRUSHES: Check every 1 to 3 months depending on use and loading conditions.

Brushes can wear rapidly if the hoist is continuously run at its maximum load all the time or especially if there is a voltage drop resulting from overlong extension leads or incorrectly sized cable extension leads.

MOTOR: Check commutator every 1 to 3 months depending on use and loading conditions.

The motor can only be checked during a major strip down. When the carbon brushes are removed, the commutator can be seen. If it is badly scored or blued, the motor should be checked by a qualified electrician.

POWER LEAD AND WANDERLEAD CONTROL: Visual inspection daily.

The power lead and wanderlead should both be inspected before use to make sure that the outer insulation isn't damaged, that all the plugs are undamaged and the cable connections into the plugs are tight. The wanderlead emergency stop button and control buttons must also be checked for free movement and correct operation.

HOIST SUPPORT HOOK AND SAFETY LOCK: Visual inspection daily.

Before use, check that the hook and support fittings are secure and are moving freely. Lubricate if necessary with light oil.

WIRE ROPE: Visual inspection daily.

Check the wire rope for damage before use. This should be done before lifting any goods by powering the rope completely out and then back on by keeping tension on the rope while doing so.

NOTE: During this operation protective gloves must be worn. Check for kinks, broken strands and flattening of the rope during this operation.

LIMITERS: Visual inspection daily.

Check the operation of the overwind and reverse winding limiters. These are important aspects of the hoist operation and crucial to overall safety.

OVERWIND LIMITER: Check the rope hook and top plate for any damage or distortion. If the top plate is distorted in anyway, it will impare the operation of the overwind limiter.

NEVER use a hook without a top plate.

REVERSE WIND LIMITER: Check that there is no damage – especially from impact, of the reverse wind limiter which could restrict its operation. The bar should be clear of the casing and free to move.

References to these limiters and their location on the hoist are listed in the **FEATURES** section (Page 7).

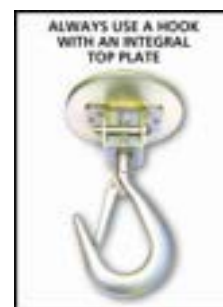

MARKING LABELS: Visual inspection at major service.

Check for wear and damage. Replace if necessary.

SERVICING

It is recommended that CWS hoists are returned to the supplier for a full service and test every 3 years or after 250 hours of use – whichever is the soonest.

TROUBLE SHOOTING

Below are some tips on trouble shooting with a CWS hoist, further advice is readily available from the BHW Group Ltd.

SYMPTOM	POSSIBLE CAUSES	CORRECTIONS
No power	Faulty wiring on power lead or poor electrical source Burnt out rectifier(s) on power source Burnt out motor Bad installation or wear on carbon brushes Power loss on carbon brushes feed	Check power lead and power source Replace rectifier(s) - note +/- poles Replace motor Check and replace both carbon brushes Check and replace both carbon brush leads
Can lift, but fails to lower	Deformed 'DOWN' spring plate on limit switch Burnt out diode Burnt out limit switch Burnt out rectifier(s) on motor side Malfunction of 'DOWN' button on wanderlead	Adjust or re-install limit switch Replace diode - note +/- poles Replace limit switch Replace rectifier(s) - note +/- poles Replace 'DOWN' switch in wanderlead
Can lower, but fails to lift	Deformed 'UP' spring plate of limit switch Burnt out limit switch Loosening of transmitting arm resulting in malfunction of 'DOWN' limit switch Loose adjustable nut Burnt out diode Burnt out rectifier(s) on motor side Malfunction of 'UP' button on wanderlead	Adjust or re-install limit switch Replace limit switch Adjust transmitting arm Adjust Replace diode - note +/- poles Replace rectifier(s) - note +/- poles Replace 'UP' switch in wanderlead
Short circuit	Melted 'B' contact of wanderlead Burnt out diode Short circuit on rectifier on motor side Burnt out 'D' type resistor Too much carbon powder on carbon brushes Burnt out motor Damaged circuit board due to over wind of wire	Relace wanderlead Replace diode (note +/- poles) Replace rectifier (note +/- poles) Replace 'D' type resistor Dis-assemble the hoist and clean out carbon powder Replace motor Replace circuit board
Failure to lift the rated load	Overloaded Short circuit on the armature winding Incorrect carbon brush specification, or worn out Burnt out parts of armature winding Burnt or deformed carbon brush holder(s)	Reduce load Replace commutator of te armature core Replace carbon brushes Replace armature winding Replace carbon brush holder(s)
Failure to hold rated load after stopping	Gap of ratchet brake is too large Malfunction of pressed spring of ratchet brake Oil dirty or contaminated Too much oil in gearbox	Adjust ratchet brake Replace pressed spring Replace oil Reduce quantity of oil
Brake distance is too long at 'no load'	Malfunction of 'D' type resistor	Check and/or replace 'D' type resistor
Smell of burning or smoke	Malfunction of pressed spring of ratchet brake Burnt out 'D' type resistor Malfunction of 'B' contact of pendant switch Hoist has debris inside, impairing operation	Replace pressed spring Replace 'D' type resistor Replace pendant switch Remove debris and clean outer housing (do not use jet sprays)

HOIST PARTS

CWS 80 PARTS DIAGRAM

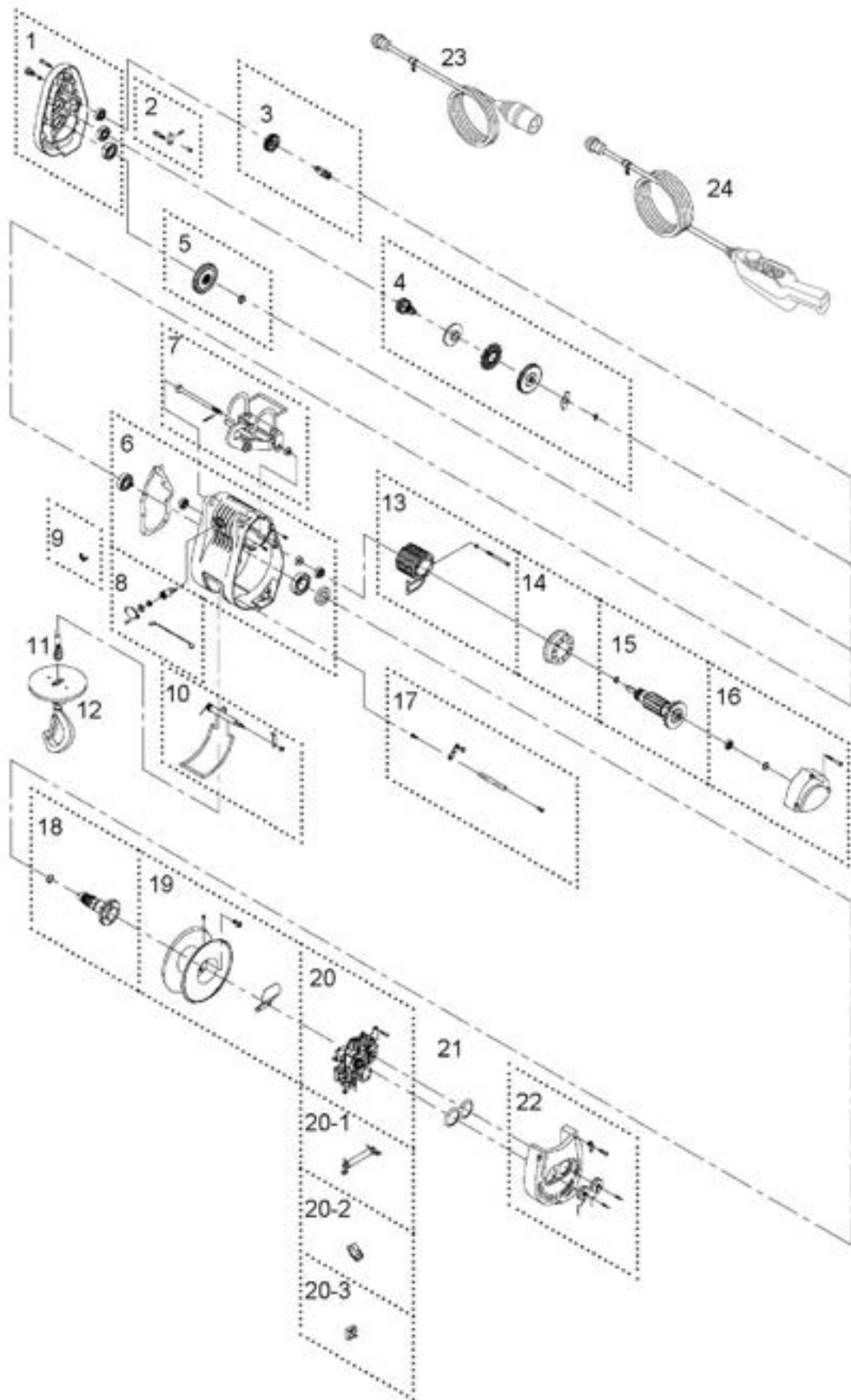

HOIST PARTS

CWS 160 / 230 / 300 PARTS DIAGRAM

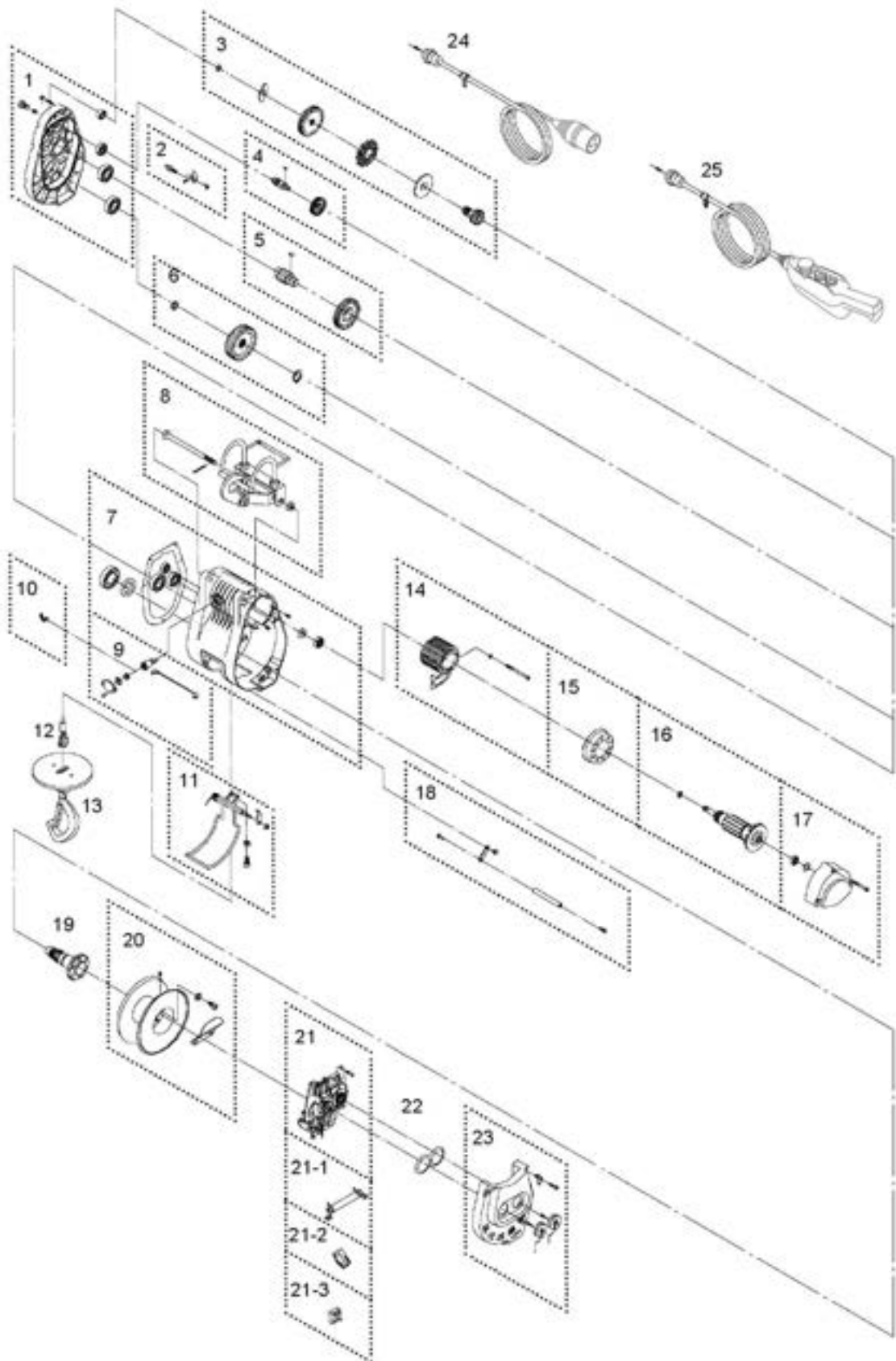

HOIST PARTS

CWS80 & CWS160

Parts description - CWS80			
No.	BHW no.	Description	Qty
1	14226	Gearbox rear cover kit	1
2	14227	Ratchet stopper kit	1
3	14228	1st gear kit	1
4	14229	Brake kit	1
5	14230	3rd gear kit	1
6	14231	Gearbox kit	1
7	14232	Hanger kit	1
8	14216	Carbon brush holder kit	2
9	2303	Carbon brush 110V~240V	2
10	14233	Over-winding bracket kit	1
11	3496	Wire rope 7 x 18 core, 4mm Ø, 24m length	1
12	14234	Weighted hook CHW-0032	1
13	14235	Armature core, 110V	1
	14236	Armature core, 240V	1
14	2244	Cooling cover	1
15	14237	Armature winding, 110V	1
	14238	Armature winding, 240V	1
16	14218	Motor rear cover kit	1
17	2276	Reverse winding shaft kit	1
18	2277	Output shaft kit	1
19	2297	Drum kit	1
20	2299	Control panel 110V	1
	2307	Control panel 240V	1
20...1	2320	D Type resistor 110V	1
	12931	D Type resistor 240V	2
20...2	2316	Limit switch	2
20...3	2319	Diode	1
21	2290	Rubber packer	1
22	14239	Electric cover kit	1
23	8244	Power lead assembly, 110V	1
	10047	Power lead assembly, 240V	1
24	19366	Wanderlead control assembly PB-417	1
24...1	14079	2 Button control + E/Stop only PB-417	1
N/S	9867	Safety hook webbing strap	1

Parts description - CWS160			
No.	BHW no.	Description	Qty
1	14209	Gearbox rear cover kit	1
2	14210	Ratchet stopper kit	1
3	14211	Brake kit	1
4	14212	1st gear kit	1
5	14213	3rd gear kit	1
6	14214	4th gear kit	1
7	14215	Gearbox kit	1
8	2296	Hanger kit	1
9	14216	Carbon brush holder kit	2
10	2303	Carbon brush 110V~240V	2
11	14217	Over-winding bracket kit	1
12	8972	Wire rope 7 x 18 core, 5mm Ø, 31m length	1
	2301	Weighted hook CHW-0033	1
14	2246	Armature core, 110V	1
	2247	Armature core, 240V	1
15	2244	Cooling cover - 881500	1
16	2242	Armature winding, 110V	1
	2243	Armature winding, 240V	1
17	14218	Motor rear cover kit	1
18	14219	Reverse winding shaft kit	1
19	14220	Output shaft kit	1
20	14221	Drum kit	1
21	2288	Control panel 110V	1
	2289	Control panel 240V	1
21...1	2320	D Type resistor 110V	1
	12931	D Type resistor 240V	2
21...2	2316	Limit switch	2
21...3	2319	Diode	1
22	2290	Rubber packer	1
23	14222	Electric cover kit	1
24	8244	Power lead assembly 110V	1
	10047	Power lead assembly 240V	1
25	19366	Wanderlead control assembly PB-417	1
25...1	14079	2 Button control + E/Stop only PB-417	1
N/S	9867	Safety hook webbing strap	1

HOIST PARTS

CWS230 & CWS300

Parts description - CWS230			
No.	BHW no.	Description	Qty
1	14209	Gearbox rear cover kit	1
2	14210	Ratchet stopper kit	1
3	14211	Brake kit	1
4	14212	1st gear kit	1
5	14213	3rd gear kit	1
6	14214	4th gear kit	1
7	14215	Gearbox kit	1
8	2296	Hanger kit	1
9	14216	Carbon brush holder kit	2
10	2303	Carbon brush 110V~240V	2
11	14217	Over-winding bracket kit	1
12	3488	Wire rope 7 x 18 core, 5mm Ø, 25m length	1
13	2301	Weighted hook CHW-0033	1
14	2246	Armature core, 110V	1
	2247	Armature core, 240V	1
15	2244	Cooling cover	1
16	2242	Armature winding, 110V	1
	2243	Armature winding, 240V	1
17	14218	Motor rear cover kit	1
18	14219	Reverse winding shaft kit	1
19	14220	Output shaft kit	1
20	14221	Drum kit	1
21	2288	Control panel 110V	1
	2289	Control panel 240V	1
21...1	2320	D Type resistor 110V	1
	12931	D Type resistor 240V	2
21...2	2316	Limit switch	2
21...3	2319	Diode	1
22	2290	Rubber packer	1
23	14222	Electric cover kit	1
24	8244	Power lead assembly 110V	1
	10047	Power lead assembly 240V	1
25	19366	Wanderlead control assembly, PB-417	1
25...1	14079	2 Button control + E/Stop only PB-417	1
N/S	9867	Safety hook webbing strap	1

Parts description - CWS300			
No.	BHW no.	Description	Qty
1	14209	Gearbox rear cover kit	1
2	14210	Ratchet stopper kit	1
3	14211	Brake kit	1
4	14212	1st gear kit	1
5	14213	3rd gear kit	1
6	14214	4th gear kit	1
7	14215	Gearbox kit	1
8	2296	Hanger kit	1
9	14216	Carbon brush holder kit	2
10	2303	Carbon brush 240V	2
11	14217	Over-winding bracket kit	1
12	3488	Wire rope 7 x 18 core, 5mm Ø, 25m length	1
13	2301	Weighted hook CHW-0033	1
14	14224	Armature core, 240V	1
15	2244	Cooling cover	1
16	14225	Armature winding, 240V	1
17	14218	Motor rear cover kit	1
18	14219	Reverse winding shaft kit	1
19	14220	Output shaft kit	1
20	14221	Drum kit	1
21	2289	Control panel 240V	1
21...1	12931	D Type resistor 240V	2
21...2	2316	Limit switch	2
21...3	2319	Diode	1
22	2290	Rubber packer	1
23	14222	Electric cover kit	1
24	10047	Power lead assembly 240V	1
25	19366	Wanderlead control assembly, PB-417	1
25...1	14079	2 Button control + E/Stop only PB-417	1
N/S	9867	Safety hook webbing strap	1

WARRANTY

BHW Group Ltd warrants each new CWS hoist and ancillary equipment supplied against factory defects in material and workmanship for one year from date of purchase.

The responsibility for uninstalling the hoist or ancillary equipment is the owner's, together with its return, transportation prepaid to BHW Group Ltd.

BHW Group Ltd will, under this warranty, without charge repair or replace at its option, parts, which on inspection are deemed to be defective.

The loss of use of the produce, loss of time, inconvenience, commercial loss or consequential damages are not covered.

Warranty does not apply where the product has been tampered with or altered in any way, or where the serial number or date stamp has been defaced, altered or removed, or if in the view of BHW Group Ltd the damage or failure occurred from misuse, negligence or accident.

NOTE: This is a mechanical product and as such requires regular, routine maintenance (see page 12). Subject to duty cycle, some consumable parts are not likely to be covered by warranty. This would typically apply to items like wire ropes and motor brushes. BHW Group Ltd will always examine any product whilst under warranty and advise accordingly.

BHW Group Ltd reserve the right to change the design of any product without assuming any obligation to modify any product previously supplied.

Hoists or equipment returned under warranty should be despatched to BHW Group Ltd service department at the address shown below, with full name and address of sender, a statement detailing the defect and proof of purchase.



Service Department
BHW Group Ltd
Unit 6, South Orbital Trading Park
Hedon Road, Hull, HU9 1NJ

Telephone: +44 (0)1482 223 663
Email: sales@bhwgroup.com
Website: www.bhwgroup.com

CWS HOIST MODEL & VOLTAGE.....
SERIAL NUMBER.....
DATE OF PURCHASE.....

CWS hoists are manufactured in Taiwan.